

Bayside Utility Center
Model BU3050

General Specifications

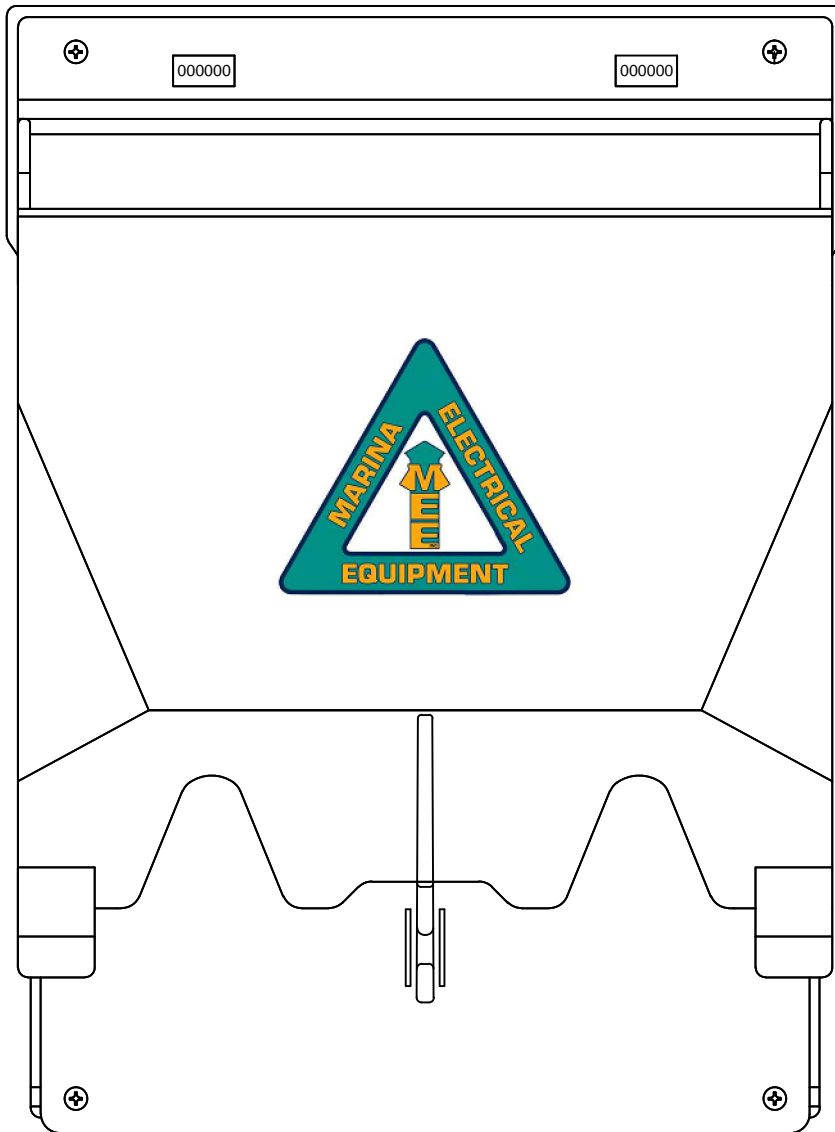

Marina Electrical Equipment, Inc.
1715 Merrimac Trail
Williamsburg, VA 23185
Toll Free: 1-855-258-3939
Fax: 1-757-258-3988



Intertek
4005786

CONFORMS TO STD. ANSI/UL231
CERT. TO CAN/CSA STAD.C22.2
NO 29

General Specifications - Bayside Utility Center BU3050

ALL Bayside Utility Center POWER PEDESTALS SHALL MEET THE FOLLOWING SPECIFICATIONS:

SECTION A: ACCEPTABLE MANUFACTURERS:

Marina Electrical Equipment, Inc.
1715 Merrimac Trail
Williamsburg, VA 23185
Toll Free: 1-855-258-3939
Web: www.marinaelectricequipment.com

SECTION B: GENERAL REQUIREMENTS

1. Utility center shall be listed and marked, tested and certified to conform to Standard ANSI/UL® 231 entitled "Power Outlets" and CAN/CSA Standard C22.2 No. 29 entitled "Panelboards and Enclosed Panelboards."
2. Shall be compliant with all sections of the latest edition of NFPA® 303, "Fire Protection Standards for Marinas and Boatyards."
3. Shall be compliant with NEC, and NFPA 70 406.8 (B)(2)(a), which states: "A receptacle installed in a wet location shall be installed in a weatherproof enclosure, the integrity of which is not affected when the attachment plug cap is inserted."

SECTION C: CONSTRUCTION REQUIREMENTS

1. All materials and components used in the construction of the power pedestal shall be listed.
2. **Main Housing:** Shall be constructed of 3/16" thick injection molded listed polycarbonate and shall be painted with a UV-resistant 2-part polyurethane coating. The housing shall be listed as a NEMA® Type 3R weatherproof enclosure.
3. **Receptacle and Circuit Breaker Faceplate:** Shall be constructed of 316L stainless steel, coated with a UV-resistant polyurethane coating.
4. **Lens:** Shall be constructed of 3/16" thick injection-molded listed clear or amber-colored polycarbonate.
5. **Hardware:** Shall be stainless steel, Phillips® drive.

SECTION D: LIGHTING

1. Each utility center shall contain a non-metered lighting assembly.
2. Lighting assembly shall be a readily available, commercially manufactured LED that is controlled by an electromechanical photocell. Optional helical compact fluorescent bulbs are also available.
3. Lighting assembly shall be protected by a 20 ampere, single pole circuit breaker or fuse.
4. Standard lighting assembly shall provide downward illumination and provide minimum dock lighting of one foot-candle at 15 feet and not interfere with boater navigation.

SECTION E: RECEPTACLES & CIRCUIT BREAKERS

1. Receptacles shall be corrosion-resistant, locking grounding type conforming to NEMA® L5-20R, NEMA® L5-30R, NEMA® SS2-50R and/or NEMA® SS1-50R requirements and are rated for marine ship-to-shore use.
2. NEMA® receptacles shall be Leviton® corrosion-resistant stainless steel or equivalent.
3. Ground Fault Circuit Interrupting (GFCI) receptacles shall conform to NEMA® 5-20R requirements.
4. GFCI Receptacles shall be Leviton® SmartLockPro® Weather Resistant, corrosion-resistant stainless steel or equivalent.
5. Receptacles shall be mounted at a minimum angle of 35° from horizontal for ship-to-shore power cord strain relief.
6. Each receptacle shall be individually protected by a thermal-magnetic type circuit breaker with 10 kAIC interrupting rating.
7. Circuit breakers shall be miniature molded case type as manufactured by Square-D®, GE®, EATON® or equivalent and mounted vertically to avoid water accumulation on or around the circuit breaker.
8. Circuit breakers and twistlock receptacles shall be assembled together on a panel section which can pivot out as a single mechanism for simplified maintenance practices.
9. Circuit breakers and receptacles shall be covered by a hinged weatherproof lockable door which must latch closed with or without the plugs and ship-to-shore power cords attached.
10. GFCI receptacles shall be covered by the same hinged weatherproof lockable door, which complies with NEC Article 406.9 (B)(1), which states: "15 and 20 ampere, 125V and 250V receptacles installed in wet locations shall have an enclosure that is weatherproof whether or not the attachment plug is inserted".

General Specifications - Bayside Utility Center BU3050

SECTION F: SOLID-STATE ELECTRIC kWh MONITORING (OPTIONAL)

1. Each utility center shall be equipped with solid-state electric monitors which output kilowatt-hours (kWh) consumption at each slip via an electromechanical counter and internally built wireless remote transmission. Wireless transmission shall be integral to the solid state electric monitor. Transmission via third-party vendors is not acceptable.
2. Each solid-state electric monitor shall be rated for 200 amperes, listed, marked and tested to conform to Standard ANSI-C12.1 and NTEP standards with $\pm 1\%$ accuracy.
3. Each solid-state electric monitor shall be capable of monitoring ground faults at each slip.

SECTION G: WIRING & TERMINAL BLOCK

1. Power pedestal shall be completely factory pre-wired to the load side of the copper 1/4" stud lug compression terminal block assembly.
2. Electrical wiring shall be high-stranding tin-plated copper THHW/MTW VW-1 Boat Cable rated for 105°C.
3. LOAD side terminations to the copper bus bar shall be made by compression-type ring terminals on 1/4"-20 stainless steel stud with, 1/4" stainless steel split-ring lock washer and 1/4"-20 silicone-bronze hex nut, torqued to 75 inch-pounds.
4. LINE side terminations to the copper bus bar shall be made by compression-type ring terminals on 1/4"-20 stainless steel stud with a stainless steel 1/4" split-ring lock washer and 1/4"-20 silicone-bronze hex nut. Maximum wiring size shall be maximum 2/0 AWG for loop feeding and 4/0 for direct feed.
5. Maximum standard terminal block load shall not exceed 140 amperes at 125/250VAC.
6. All exposed metallic parts shall be grounded as part of the integral equipment ground.

SECTION H: TELEPHONE, CABLE TELEVISION, INTERNET (OPTIONAL)

1. Power pedestals shall be capable of providing single and/or dual telephone (RJ-11), cable television (F), and internet (RJ-45) connectors.
2. Low voltage telephone, cable television, and internet connections must be mounted under a weatherproof protective cover.

END OF SECTION

General Specifications - Bayside Utility Center BU3050

SECTION K:WARRANTY POLICY

Housings:

Marina Electrical Equipment, Inc. (MEE) warrants that the main housing and attached parts (top, lens, doors, receptacle faceplates, circuit breaker plates, and mounting base plate) will be free from failure resulting from defects in material and/or workmanship, and are covered by a limited warranty of one (1) year. Should any of the above parts fail to comply with the above-mentioned warranty, MEE will either repair or replace the defective part(s), or credit the purchaser for the purchase price of the part. This warranty is voided if any petroleum-based solvent is used anywhere on or near any of the polycarbonate parts. These parts include, but may not be limited to: the top, lens, doors, receptacle faceplates, circuit breaker plates, terminal block, and the mounting base plate.

Internal Components:

MEE warrants that all internal electrical components shall be covered by a limited warranty of one (1) year. Items covered include: receptacles, circuit breakers, photocells, lamp holders, coil transformers, counters and wiring harnesses. Should any of the above parts fail to comply with this warranty policy, MEE will coordinate the repair or replacement of the defective part(s) with the respective supplier.

Solid-State Electric kWh Monitors:

MEE warrants that the International Intelligent Meter (IIM) solid-state electric kWh monitors will be free from failure resulting from defects in material and/or workmanship, and are covered for one (1) year. Although the IIM meters contain integrated surge protection, MEE and IIM will not warrant the product against severe over-voltage conditions such as lightning strikes or abnormal utility surges. Should an electric monitor fail to comply with the above-mentioned warranty, MEE will either repair or replace the defective part(s)/components, or credit the purchaser for the purchase price of the part. This warranty is voided if the damage to any or all of the components is the result of abuse, misuse, or Force Majeure. This warranty is voided if the factory seal is broken or manipulated.

This warranty policy does not cover damage or failure resulting from abuse, misuse, negligence or Force Majeure. All warranty claims must be made in writing and all defective products shall be returned to MEE for evaluation unless stated otherwise by MEE. MEE will not be responsible for reimbursing the purchaser for any sort of expense incurred by the purchaser as a result of the repair or replacement of a warranty claim.

Send all warranty claims to:

Marina Electrical Equipment, Inc.
1715 Merrimac Trail
Williamsburg, VA 23185
Toll Free:1-855-258-3939
Fax: 757-258-3988

Specifications Subject to Change Without Notice

END OF SECTION

General Specifications - Bayside Utility Center BU3050

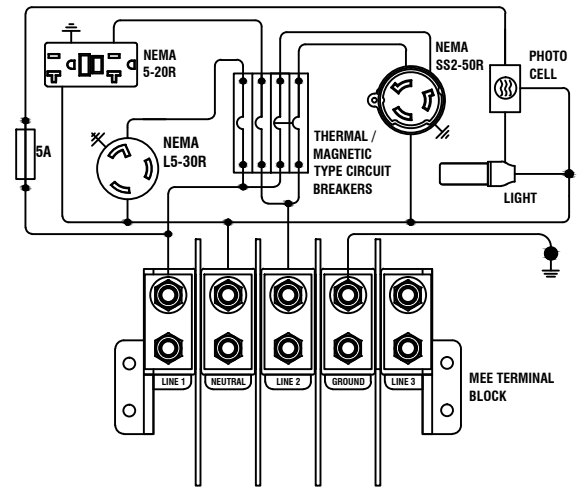
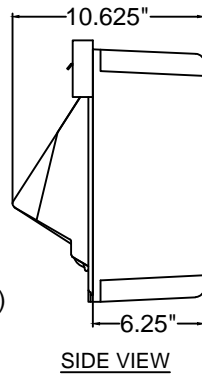
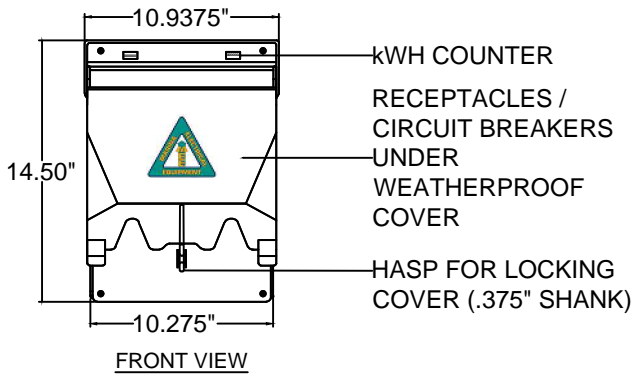

TYPICAL WIRING DIAGRAM*

*Varies based on receptacle and circuit breaker selection

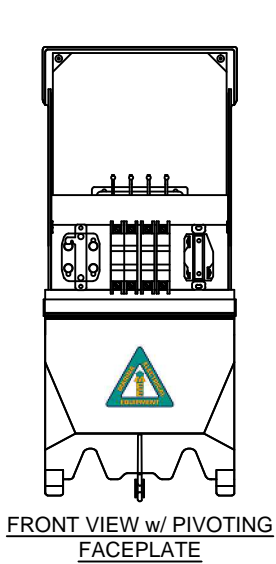

PIVOTING
FACEPLATE
ASSEMBLY FOR
SIMPLIFIED
MAINTENANCE

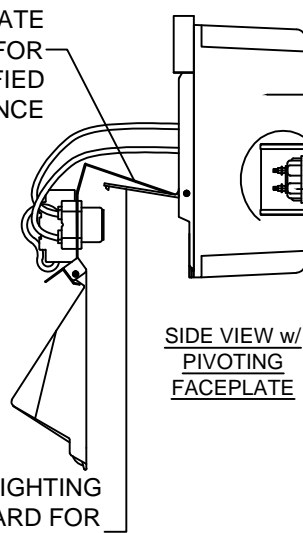

PIVOT THE LIGHTING
LENS UPWARD FOR
ACCESS TO THE
LIGHTING ASSEMBLY

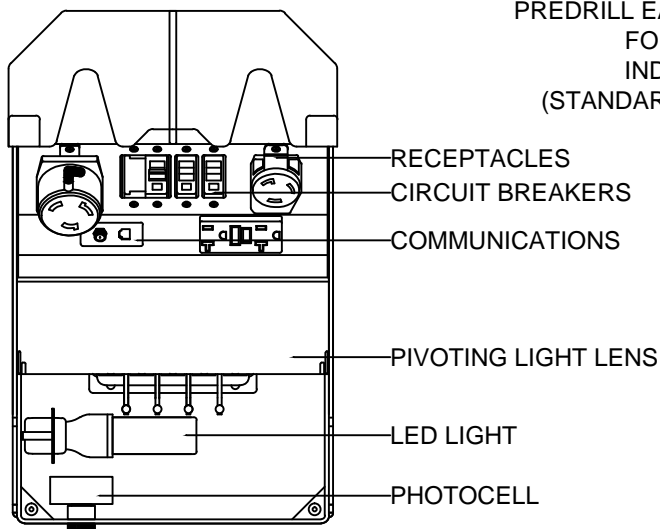
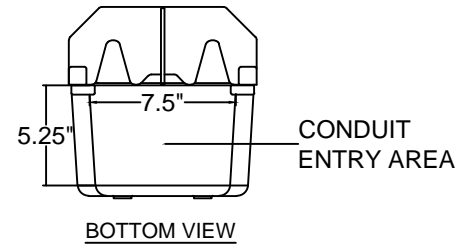

PREDRILL EACH OF THE
FOUR (4) 1/4" Ø
INDENTATIONS
(STANDARD METHOD)

